

USB and the Real World

Signal 11
S O F T W A R E

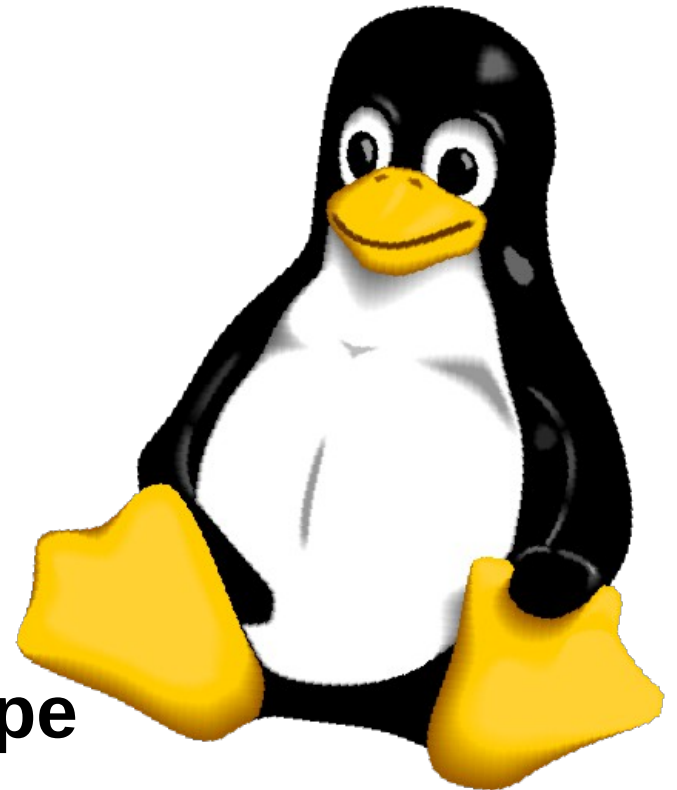

Alan Ott
Embedded Linux Conference - Europe
October 14, 2014

About the Presenter

- Chief Bit-Banger at **Signal 11 Software**
 - Products and **consulting services**
- **Linux Kernel**
- **Firmware**
- **Userspace**
- **Training**
- **USB**
 - M-Stack USB Device Stack for PIC
- **802.15.4 wireless**



USB Overview



USB Bus Speeds

- **Low Speed**
 - 1.5 Mb/sec
- **Full Speed**
 - 12 Mb/sec
- **High Speed**
 - 480 Mb/sec
- **Super Speed**
 - 5.0 Gb/sec



USB Bus Speeds

- Bus speeds are the **rate of bit transmission** on the bus
- Bus speeds are **NOT** data transfer speeds
- USB protocol can have **significant overhead**
- USB overhead **can be mitigated** if your protocol is designed correctly.



USB Standards

- **USB 1.1** – 1998
 - Low Speed / Full Speed
- **USB 2.0** – 2000
 - High Speed added
- **USB 3.0** – 2008
 - SuperSpeed added
- USB Standards **do NOT** imply a bus speed!
 - A **USB 2.0** device can be High Speed, Full Speed, or Low Speed



USB Terminology

- **Device** – Logical or physical entity which performs a function.
 - Thumb drive, joystick, etc.
- **Configuration** – A mode in which to operate.
 - Many devices have one configuration.
 - Only one configuration is active at a time.

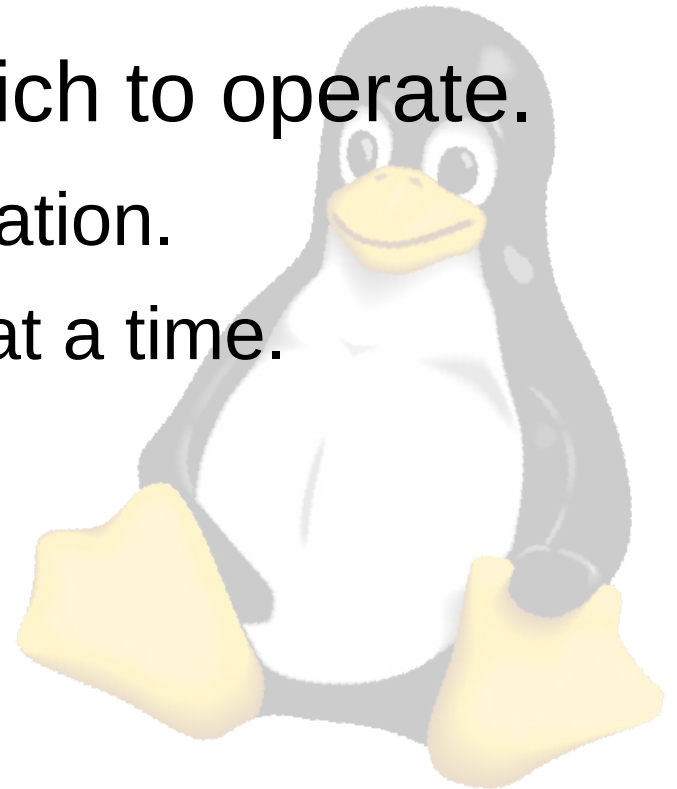

USB Terminology

- **Interface** – A related set of Endpoints which present a single feature or function to the host.
 - A configuration may have **multiple** interfaces
 - All interfaces in a configuration are **active at the same time**.
- **Endpoint** – A source or sink of data
 - Interfaces often contain **multiple endpoints**, each active all the time.



Logical USB Device

USB Device

Configuration 1

Interface 0

Endpoint 1 OUT

Endpoint 1 IN

Endpoint 2 IN

Interface 1

Endpoint 3 OUT

Endpoint 3 IN

Configuration 2

Interface 0

Endpoint 1 OUT

Endpoint 1 IN

Interface 1

Endpoint 2 OUT

Endpoint 2 IN

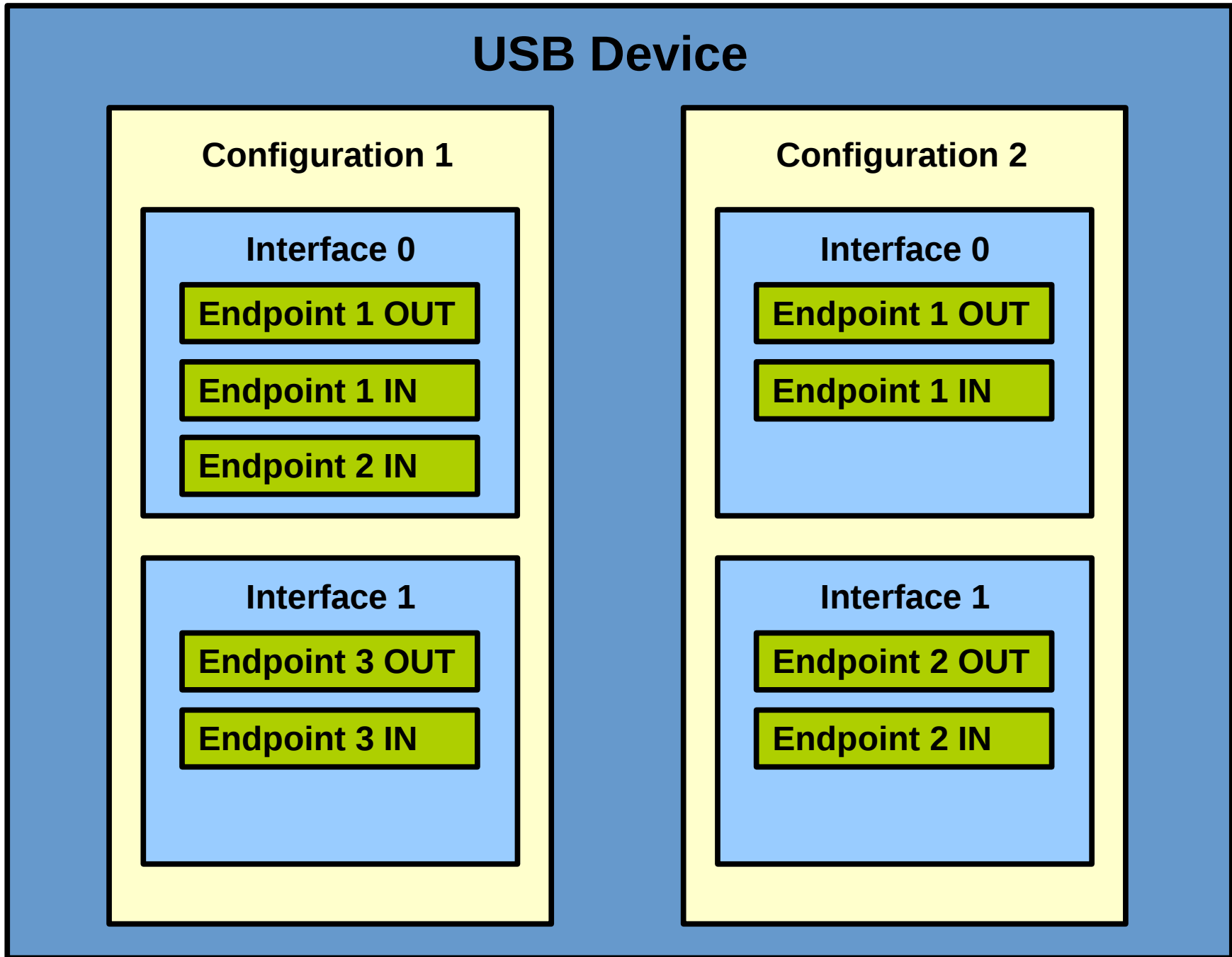

Endpoints

- Four types of Endpoints
 - **Control**
 - **Bi-directional** pair of endpoints
 - Status stage can return success/failure
 - **Multi-stage** transfers
 - Used during **enumeration**
 - Can also be used for application
 - Mostly used for configuration items



Endpoints

- **Interrupt**
 - Transfers a **small amount** of **low-latency** data
 - Used for **time-sensitive** data (HID).
 - Reserves bandwidth on the bus
- **Bulk**
 - Used for **large, time-insensitive** data (Network packets, Mass Storage, etc).
 - Does not reserve bandwidth on bus
 - Uses whatever time is left over



Endpoints

- **Isochronous**

- Transfers a **large amount of time-sensitive** data
- Delivery is **not guaranteed**
 - **No ACKs are sent**
- Used for Audio and Video streams
 - Late data is as good as no data
 - Better to drop a frame than to delay and force a re-transmission



Endpoints

- **Endpoint Length**

- The **maximum amount of data** an endpoint can support sending or receiving **per transaction**.
- Max endpoint sizes:
 - Full-speed:
 - Bulk/Interrupt: **64**
 - Isoc: **1024**
 - High-Speed:
 - Bulk: **512**
 - Interrupt: **3072**
 - Isoc: **1024 x3**



Transfers

- **Transaction**
 - Delivery of service to an endpoint
 - Max data size: **Endpoint length**
- **Transfer**
 - **One or more** transactions moving information between host and device.
 - *Transfers can be large, even on small endpoints!*



Transfers

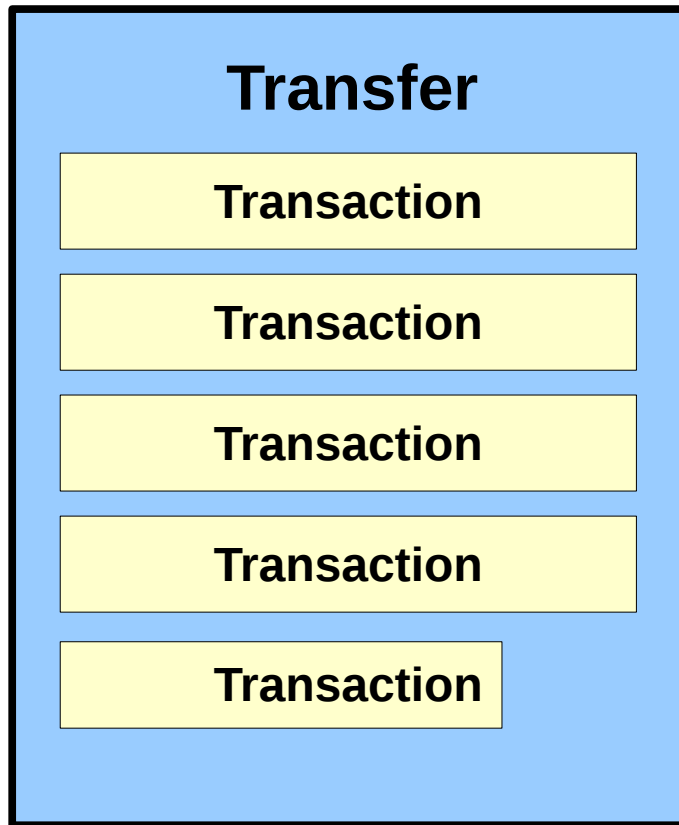

- Transfers contain **one or more transactions.**
- Transfers are ended by:
 - A **short transaction**
 - OR
 - When the **desired amount of data** has been transferred
 - *As requested by the host*



Terminology

- In/Out
 - In USB parlance, the terms **In** and **Out** indicate direction from the **Host** perspective.
 - **Out**: Host to Device
 - **In**: Device to Host



The Bus

- USB is a **Host-controlled** bus
 - Nothing on the bus happens without the host first initiating it.
 - Devices cannot initiate a transaction.
- The USB is a **Polled Bus**
 - Devices cannot interrupt the host
 - The Host polls each device, requesting data or sending data.



Transactions

- **IN** Transaction (Device to Host)
 - Host sends an **IN token**
 - If the device has data:
 - Device sends data
 - Host sends **ACK**
 - else
 - Device sends **NAK**
 - *If the device sends a **NAK**, the host will retry repeatedly until timeout.*



Transactions

- **OUT** Transaction (Host to Device)
 - Host sends an **OUT** token
 - Host sends the data (up to endpoint length)
 - Device sends an **ACK** (or **NAK**).
 - *The data is sent before the device has a chance to respond at all.*
 - *In the case of a **NAK**, the host will **retry** until timeout or success.*



Transactions

- All traffic is initiated by the **Host**
- In **user space**, this is done from **libusb**:
 - Synchronous:
 - `libusb_control_transfer()`
 - `libusb_bulk_transfer()`
 - `libusb_interrupt_transfer()`
 - Asynchronous:
 - `libusb_submit_transfer()`

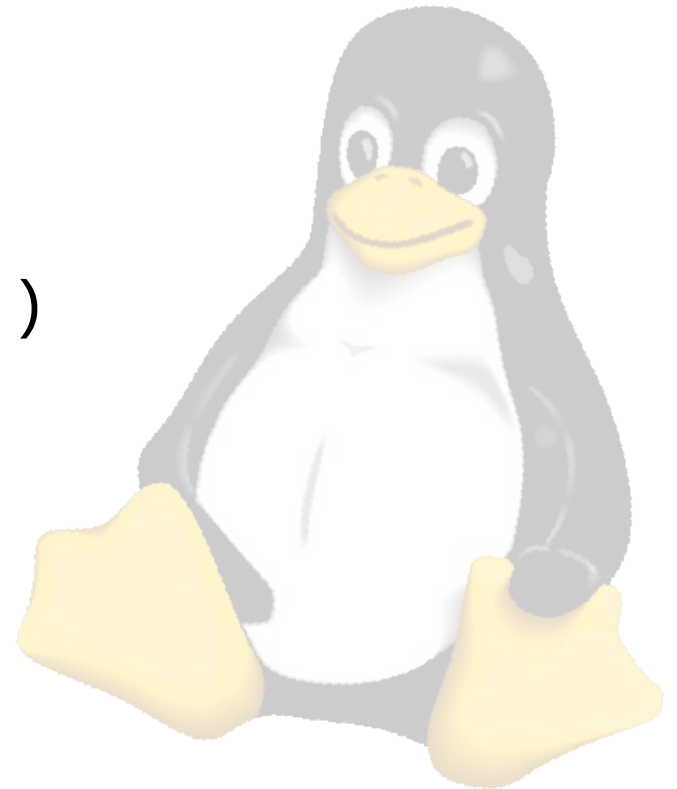

Transactions

- In **kernel space**, this is done from:
 - Synchronous:
 - `usb_control_msg()`
 - `usb_bulk_msg()`
 - `usb_interrupt_msg()`
 - Asynchronous:
 - `usb_submit_urb()`



Transactions

- For All types of Endpoint:
 - The Host **will not send** any IN or OUT tokens on the bus unless a **transfer object is active**.
 - The bus is **idle** otherwise
 - Create and submit a transfer object using the functions on the preceding slides.

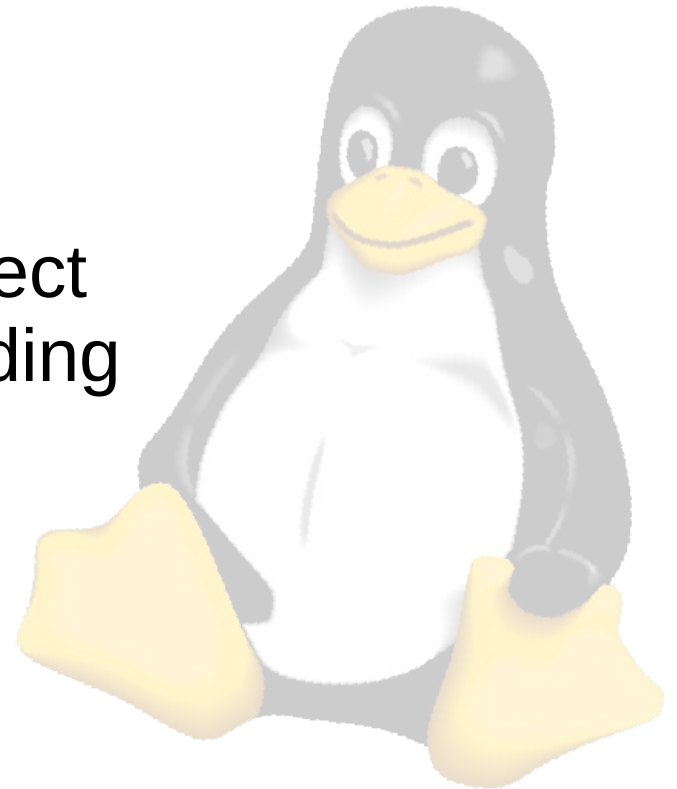

Linux USB Gadget Interface and Hardware



USB Gadget Interface

- Linux supports **USB Device Controllers (UDC)** through the **Gadget** framework.
 - Kernel sources in `drivers/usb/gadget/`
- The gadget framework has transitioned to use **configs** for its configuration



USB Device Hardware

- UDC hardware is not standardized
 - This is different from most host controllers
 - We will focus on **musb**, **EG20T**, and **PIC32**
 - **musb**
 - IP core by Mentor Graphics
 - Recently becoming usable
 - Common on ARM SoC's such as the AM335x on the **BeagleBone Black (BBB)**
 - Host and Device



USB Device Hardware

- **Intel EG20T Platform Controller Hub (PCH)**
 - Common on Intel-based x86 embedded platforms
 - Part of many industrial System-on-Module (SoM) parts
 - Device Only (EHCI typically used for Host)
- **Microchip PIC32MX**
 - Microcontroller
 - Does not run Linux (firmware solution)
 - Full-speed only
 - **M-Stack** OSS USB Stack



Test Hardware



Test Hardware

- **BeagleBone Black**
 - Texas Instruments / CircuitCo
 - AM3359, ARM Cortex-A8 SOC
 - 3.3v I/O, 0.1" spaced connectors
 - Boots mainline kernel and u-boot!
 - Ethernet, USB host and device (musb), Micro SD
 - Great for breadboard prototypes
 - <http://www.beagleboard.org>

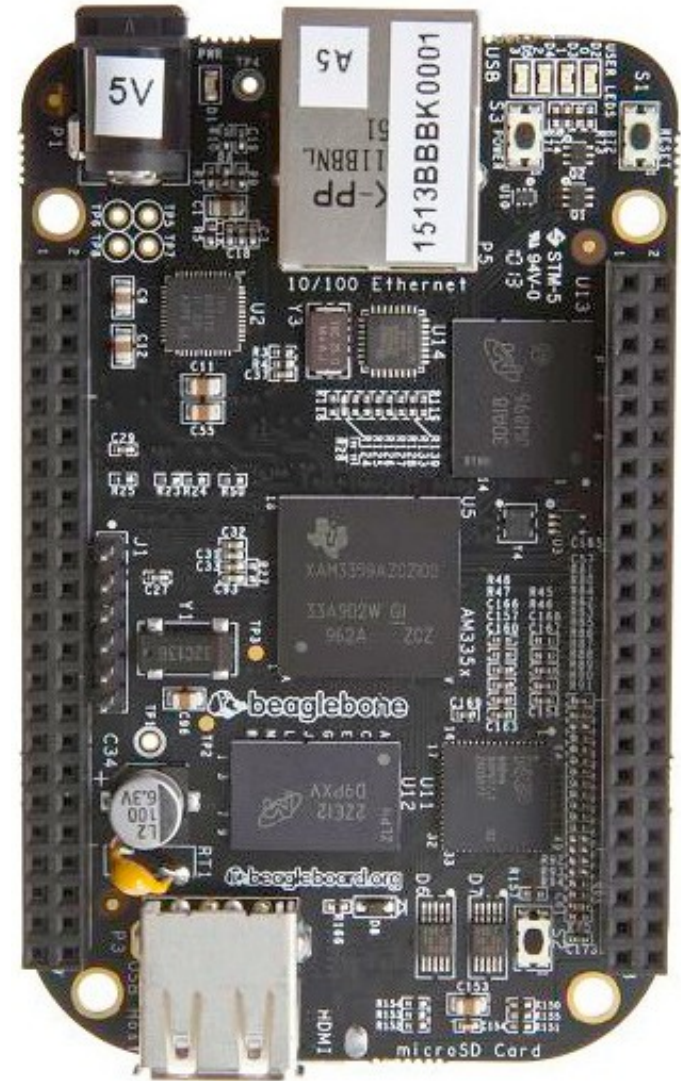

Image from beagleboard.org

Test Hardware

- OEM **Intel Atom**-based board
 - Intel Atom E680
 - 1.6 GHz x86 hyperthreaded 32-bit CPU
 - 1 GB RAM
 - Intel **EG20T** platform controller
 - Supports USB Device (pch_udc driver)
 - Serial, CAN, Ethernet, more...



Test Hardware

- **ChipKit Max32**

- PIC32MX795F512L

- 32-bit Microcontroller
 - Up to 80 MHz (PLL)
 - Running at 60 MHz here
 - Full Speed USB
 - **M-Stack** OSS USB Stack
 - 512 kB flash
 - 128 kB RAM
 - Serial, CAN, Ethernet, SPI, I2C, A/D, RTCC
 - <http://chipkit.net>

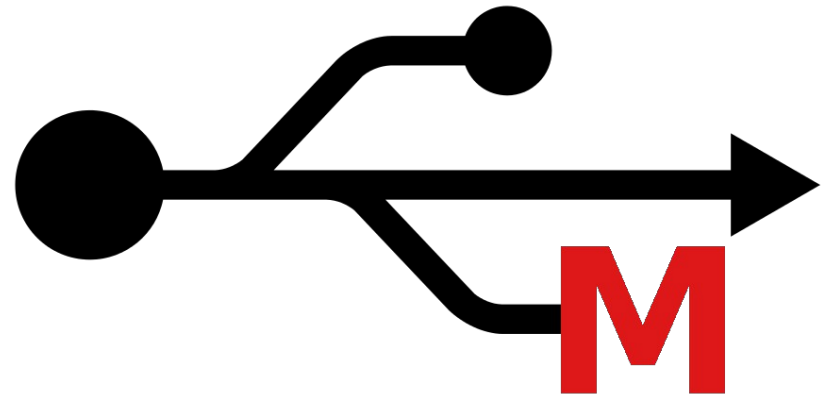

Performance

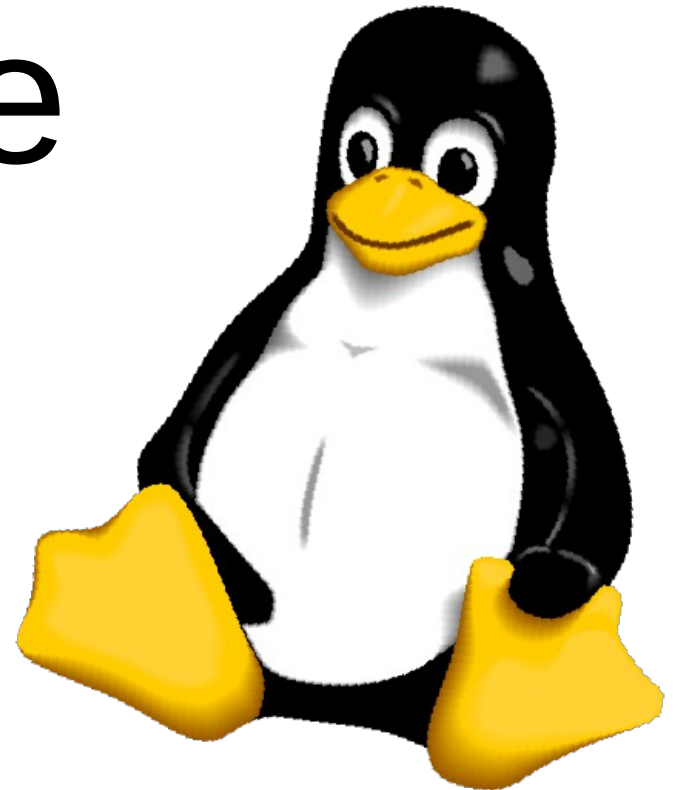

Performance

- Three classes of USB device:
 1. Designer wants an **easy, well-supported connection** to a PC
 2. Designer wants to make use of an **existing device class** and not write drivers
 3. Designer wants #1 but also wants to **move a lot of data** quickly.



Performance

- For Cases #1 and #2, naïve methods can get the job done:
 - HID (*Not recommended for generic devices*)
 - Simplistic software on both the host and device side
 - For #2, **no software** on the host side!
 - Synchronous interfaces copied from examples
- What about where we need performance?



Performance

- A simple example:
 - High-speed Device
 - 512-byte bulk endpoints
 - **Receive** data from device using **libusb** in logical application-defined blocks
 - In this case let's use **64-bytes**



Simple Example - Host

```
unsigned char buf[64];
int actual_length;

do {
    /* Receive data from the device */
    res = libusb_bulk_transfer(handle, 0x81, buf,
                              sizeof(buf), &actual_length, 100000);
    if (res < 0) {
        fprintf(stderr, "bulk transfer (in): %s\n",
                libusb_error_name(res));
        return 1;
    }
} while (res >= 0);
```

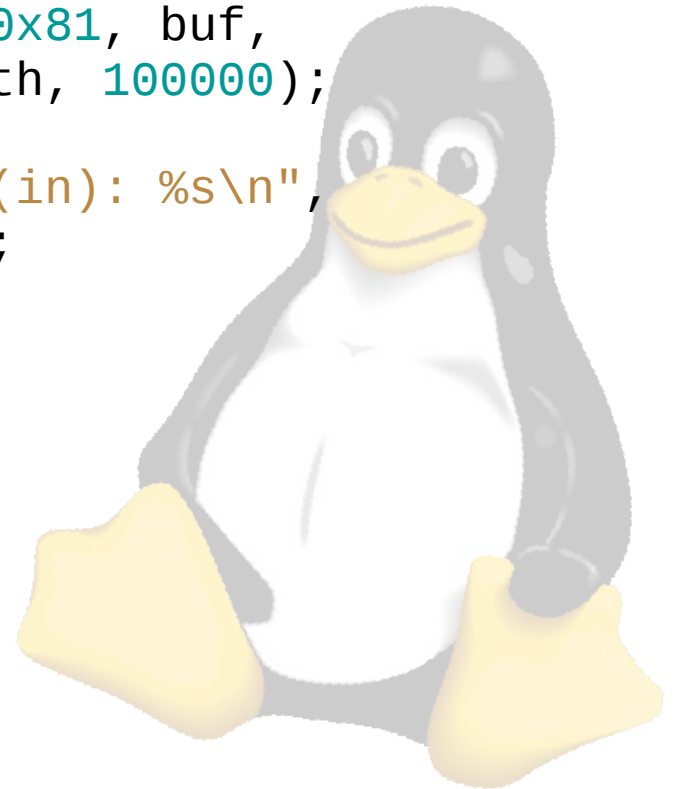

Simple Example - Device

```
#!/bin/sh -ex
```

```
# Setup the device (configs)
```

```
modprobe libcomposite
```

```
mkdir -p config
```

```
mount none config -t configs
```

```
cd config/usb_gadget/
```

```
mkdir g1
```

```
cd g1
```

```
echo 0x1a0a >idVendor
```

```
echo 0xbadd >idProduct
```

```
mkdir strings/0x409
```

```
echo 12345 >strings/0x409/serialnumber
```

```
echo "Signal 11" >strings/0x409/manufacture
```

```
echo "Test" >strings/0x409/product
```

```
mkdir configs/c.1
```

```
mkdir configs/c.1/strings/0x409
```

```
echo "Config1" >configs/c.1/strings/0x409/configuration
```

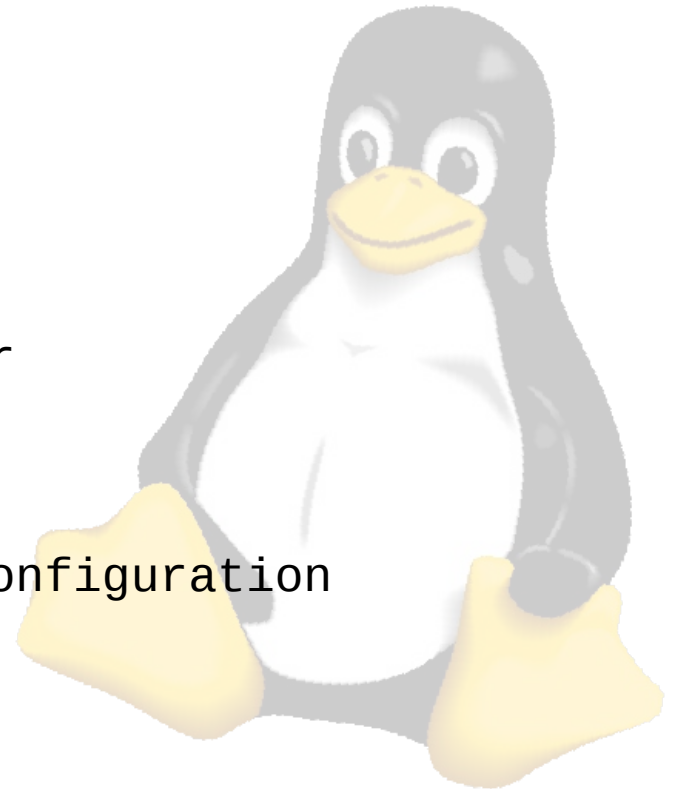

Simple Example – Device (cont'd)

```
# Setup functionfs
```

```
mkdir functions/ffs.usb0
```

```
ln -s functions/ffs.usb0 configs/c.1
```

```
cd ../../../../
```

```
mkdir -p ffs
```

```
mount usb0 ffs -t functionfs
```

```
cd ffs
```

```
../ffs-test 64 & # from the Linux kernel, with mods!
```

```
sleep 3
```

```
cd ..
```

```
# Enable the USB device
```

```
echo musb-hdrc.0.auto >config/usb_gadget/g1/UDC
```



Simple Example - Results

- On the BeagleBone Black:
 - Previous example will transfer at **4 Mbit/sec** !
 - Remember this is a high-speed device!
 - Clearly far too slow!
 - What can be done?



Performance Enhancements

- The simple example used libusb's **synchronous API**.
 - Good for **infrequent, single** transfers.
 - Easy to use, blocking, return code
 - Bad for any kind of **performance-critical** applications.
 - Why? Remember the nature of the USB bus....

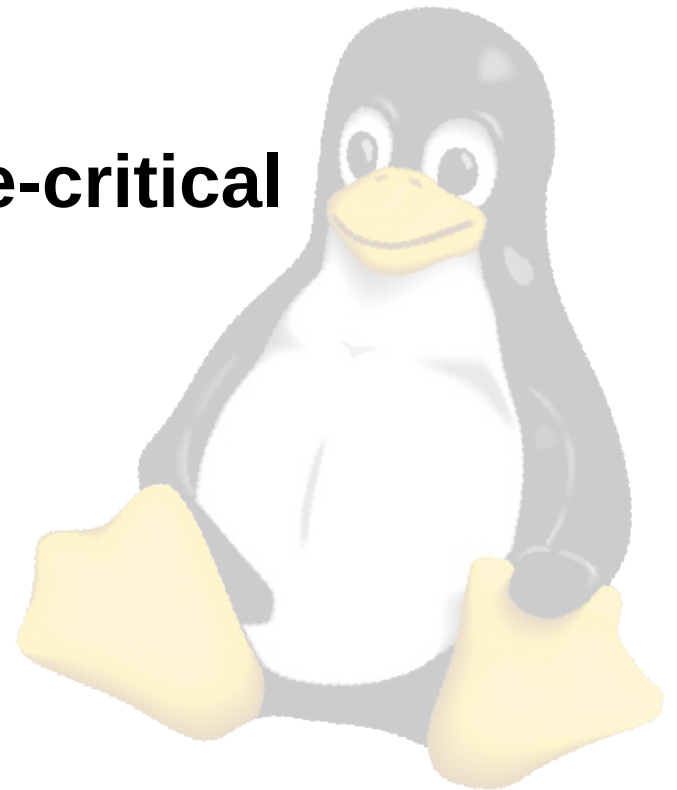

Synchronous API Issues

- The USB Bus
 - Entirely host controlled
 - Device only sends data when the host controller specifically **asks** for it.
 - The host controller will only ask for data when a **transfer object is active**.
 - libusb **creates a transfer object** when (in our example) `libusb_bulk_transfer()` is called.



Synchronous API Issues

Host

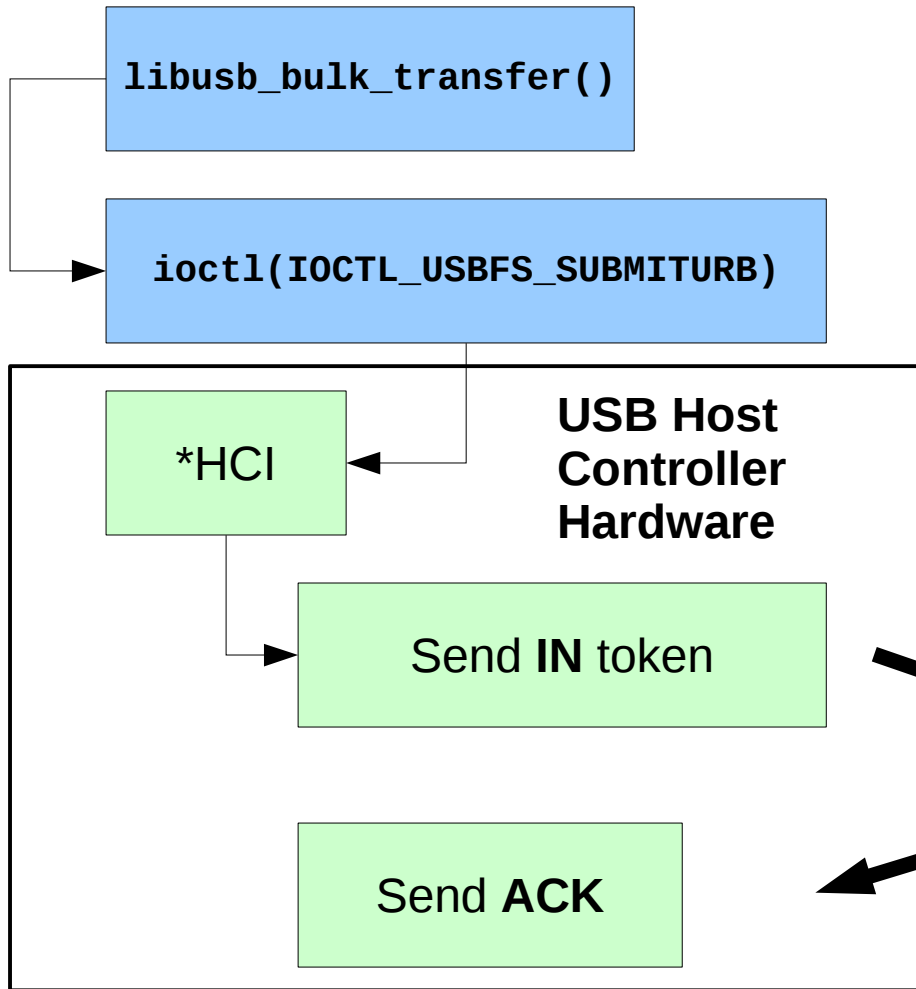

Device

USB Transaction

Send data packet

Synchronous API Issues

- USB Bus
 - After a transfer completes, the device **will not send any more data** until another transfer is created and submitted!
 - In our simple example, this is done with `libusb_bulk_transfer()` in a **tight loop**.
 - Tight loops are **not tight enough!**
 - For short transfers time spent in software will be more than time spent in hardware!
 - All time spent in software is time a **transfer is not active!**



Asynchronous API

- Fortunately libusb and the kernel provide an **asynchronous API**.
 - Create **multiple** transfer objects
 - **Submit** transfer objects to the kernel
 - Receive **callback** when transfers complete
- When a transfer completes, there is another (submitted) transfer already queued.
 - **No downtime** between transfers!



Better Example - Host

```
static struct libusb_transfer
*create_transfer(libusb_device_handle *handle, size_t length) {
    struct libusb_transfer *transfer;
    unsigned char *buf;

    /* Set up the transfer object. */
    buf = malloc(length);
    transfer = libusb_alloc_transfer(0);
    libusb_fill_bulk_transfer(transfer,
        handle,
        0x81 /*ep*/,
        buf,
        length,
        read_callback,
        NULL/*cb data*/,
        5000/*timeout*/);

    return transfer;
}
```



Better Example – Host (cont'd)

```
static void read_callback(struct libusb_transfer *transfer)
{
    int res;

    if (transfer->status == LIBUSB_TRANSFER_COMPLETED) {
        /* Success! Handle data received */
    }
    else {
        printf("Error: %d\n", transfer->status);
    }

    /* Re-submit the transfer object. */
    res = libusb_submit_transfer(transfer);
    if (res != 0) {
        printf("submitting. error code: %d\n", res);
    }
}
```

Better Example – Host (cont'd)

```
/* Create Transfers */
for (i = 0; i < 32; i++) {
    struct libusb_transfer *transfer =
        create_transfer(handle, buflen);
    libusb_submit_transfer(transfer);
}

/* Handle Events */
while (1) {
    res = libusb_handle_events(usb_context);
    if (res < 0) {
        printf("handle_events()error # %d\n",
            res);

        /* Break out of this loop only on fatal error.*/
        if (res != LIBUSB_ERROR_BUSY &&
            res != LIBUSB_ERROR_TIMEOUT &&
            res != LIBUSB_ERROR_OVERFLOW &&
            res != LIBUSB_ERROR_INTERRUPTED) {
            break;
        }
    }
}
```

Asynchronous API

- This example creates and queues **32 transfers**.
- When a transfer completes, the completed transfer object is **re-queued**.
- All the transfers in the queue can conceivably complete **without a trip to userspace**.
- Results on BeagleBone Black:
 - **15 Mbit/sec**
 - A little better, but still not good!

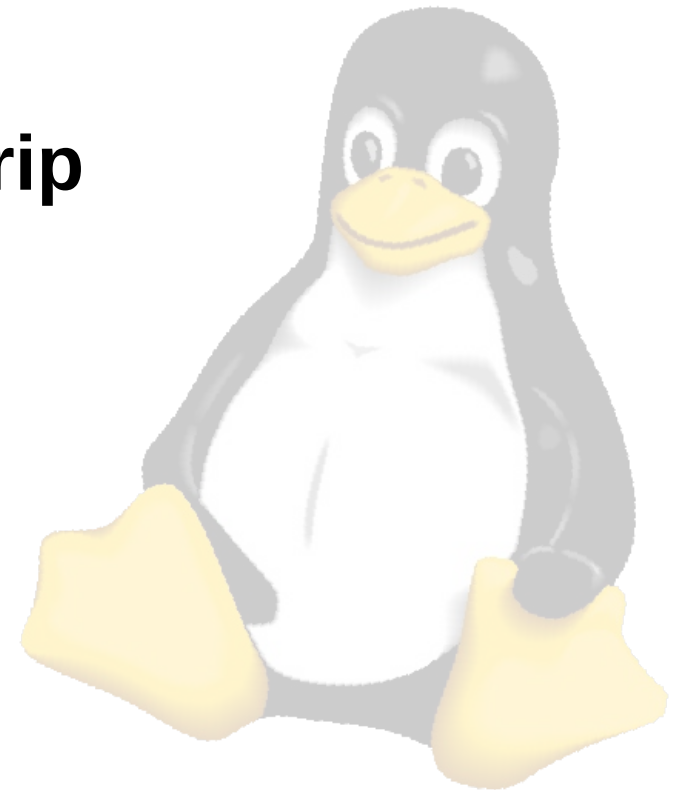

Transfer Size

- The previous examples used a **64-byte** transfer size.
 - One short transaction per transfer
- *The max bulk endpoint size is **512-bytes**.*
- Larger transactions mean less overhead.
 - Each transaction requires three packets
 - **Token** phase
 - **Data** phase
 - **Handshake** phase (ACK/NAK)
 - Longer data packets means fewer transactions.



Transfer Size

- Results:
 - On BeagleBone Black, 512-byte transfers using the asynchronous API yields:
 - **82 Mbit/sec**
 - Better, but still sub-optimal
 - Why still so slow?
 - Transaction size is maximal...
 - Host side latency is minimal...
 - Use analyzer to find out.



USB Analyzer

- TotalPhase Beagle Analyzers
 - Beagle USB 480 Power Protocol Analyzer
 - Well supported on Linux
 - Class-level debugging
 - Power (current/voltage) analysis
 - <http://www.totalphase.com>



USB Analyzer

512-byte transfers

↕	269962	1:51.484.971	512 B	05	01	■	IN txn [33 POLL]	
↕	269967	1:51.485.059	83 ns				[1 SOF]	
↕	269968	1:51.485.020	512 B	05	01		IN txn [25 POLL]	
↕	269973	1:51.485.075	512 B	05	01		IN txn [34 POLL]	
↕	269978	1:51.485.124	512 B	05	01		IN txn [34 POLL]	
↕	269983	1:51.485.184	83 ns				[1 SOF]	
↕	269984	1:51.485.186	512 B	05	01		IN txn [19 POLL]	
↕	269989	1:51.485.219	512 B	05	01		IN txn [34 POLL]	
↕	269994	1:51.485.309	83 ns				[1 SOF]	
↕	269995	1:51.485.268	512 B	05	01		IN txn [27 POLL]	
↕	270000	1:51.485.324	512 B	05	01		IN txn [34 POLL]	
↕	270005	1:51.485.374	512 B	05	01		IN txn [34 POLL]	
↕	270010	1:51.485.434	83 ns				[1 SOF]	
↕	270011	1:51.485.436	512 B	05	01		IN txn [21 POLL]	
↕	270016	1:51.485.472	512 B	05	01		IN txn [33 POLL]	
↕	270021	1:51.485.559	66 ns				[1 SOF]	
↕	270022	1:51.485.520	512 B	05	01		IN txn [25 POLL]	
↕	270027	1:51.485.574	512 B	05	01		IN txn [34 POLL]	
↕	270032	1:51.485.623	512 B	05	01		IN txn [34 POLL]	
↕	270037	1:51.485.684	66 ns				[1 SOF]	
↕	270038	1:51.485.686	512 B	05	01		IN txn [21 POLL]	

~55 uSec per transaction

USB Analyzer

- Opening the transactions gives more insight

HS	↕	269957	1:51.484.936	512 B	05	01	IN txn [21 POLL]
HS	↕	269962	1:51.484.971	512 B	05	01	IN txn [33 POLL]
HS	↕	269967	1:51.485.059	83 ns			[1 SOF]
HS	↕	269968	1:51.485.020	512 B	05	01	IN txn [25 POLL]
HS	↕	269969	1:51.485.020	25.2 us	05	01	[25 IN-NAK]
HS	↕	269970	1:51.485.061	3 B	05	01	IN packet
HS	↕	269971	1:51.485.061	515 B	05	01	DATA1 packet
HS	↕	269972	1:51.485.070	1 B	05	01	ACK packet
HS	↕	269973	1:51.485.075	512 B	05	01	IN txn [34 POLL]
HS	↕	269974	1:51.485.075	34.9 us	05	01	[34 IN-NAK]
HS	↕	269975	1:51.485.110	3 B	05	01	IN packet
HS	↕	269976	1:51.485.110	515 B	05	01	DATA0 packet
HS	↕	269977	1:51.485.119	1 B	05	01	ACK packet
HS	↕	269978	1:51.485.124	512 B	05	01	IN txn [34 POLL]
HS	↕	269983	1:51.485.184	83 ns			[1 SOF]
HS	↕	269984	1:51.485.186	512 B	05	01	IN txn [19 POLL]
HS	↕	269989	1:51.485.219	512 B	05	01	IN txn [34 POLL]
HS	↕	269994	1:51.485.309	83 ns			[1 SOF]
HS	↕	269995	1:51.485.268	512 B	05	01	IN txn [27 POLL]
HS	↕	270000	1:51.485.324	512 B	05	01	IN txn [34 POLL]

Host Requests data

Device sends NAKs for 41 us. (device latency)

5 us between ACK and next request (host latency)

USB Analyzer

- Observations
 - Certainly the 41us of NAK time is **less than ideal**.
 - Don't be fooled by the displayed 5us between transactions.
 - There's more to the story!
 - The bus scheduler can **adapt** to the actual time between packets.
 - Number of IN-NAKs will **go down**
 - Time will stay the **same**.
 - Don't count NAKs; look at times!



Transfer Sizes

- What changes with **multi-transaction** transfers?
 - Depends on the UDC hardware.
 - Many UDC controllers use **DMA** at the **Transfer-level**.
 - One **DMA transfer** per USB transfer.
 - Minimizing the number of DMA transfers will decrease DMA overhead.
 - Decrease the number of transfers by **increasing the transfer size**.
 - Fewer trips to user-space!



Transfer Sizes

- Increased transfer size
 - Limited by hardware/DMA/Driver
 - **64kB** seems to work well
 - Performance increases with transfer size up to 64k and plateaus in testing.
 - Performance with 64kB transfers:
 - BeagleBone Black: **211 Mbit/sec**
 - Intel E680 Board: **305 Mbit/sec**



USB Analyzer – Large Transfers

Example: Transfer size = 2047 (512 * 3 + 511)

353613	0:06.625.332	512 B	03	01	IN txn
353617	0:06.625.343	511 B	03	01	IN txn [7 POLL]
353622	0:06.625.363	512 B	03	01	IN txn [39 POLL]
353627	0:06.625.414	512 B	03	01	IN txn [7 POLL]
353632	0:06.625.432	512 B	03	01	IN txn [7 POLL]
353637	0:06.625.456	66 ns			[1 SOF]
353638	0:06.625.457	511 B	03	01	IN txn
353642	0:06.625.471	512 B	03	01	IN txn [39 POLL]
353647	0:06.625.521	512 B	03	01	IN txn [6 POLL]
353652	0:06.625.537	512 B	03	01	IN txn [6 POLL]
353657	0:06.625.554	511 B	03	01	IN txn [6 POLL]

Single Transfer

Transfers end with the 511-byte transaction



USB Analyzer – Large Transfers

Same Transfer, but with first two transactions open

353617	0:06.625.343	511 B	03	01	IN txn [7 POLL]
353622	0:06.625.363	512 B	03	01	IN txn [39 POLL]
353623	0:06.625.363	39.4 us	03	01	[39 IN-NAK]
353624	0:06.625.404	3 B	03	01	IN packet
353625	0:06.625.404	515 B	03	01	DATA0 packet
353626	0:06.625.413	1 B	03	01	ACK packet
353627	0:06.625.414	512 B	03	01	IN txn [7 POLL]
353628	0:06.625.414	6.61 us	03	01	[7 IN-NAK]
353629	0:06.625.421	3 B	03	01	IN packet
353630	0:06.625.422	515 B	03	01	DATA1 packet
353631	0:06.625.431	1 B	03	01	ACK packet
353632	0:06.625.432	512 B	03	01	IN txn [7 POLL]
353637	0:06.625.456	66 ns			[1 SOF]
353638	0:06.625.457	511 B	03	01	IN txn
353642	0:06.625.471	512 B	03	01	IN txn [39 POLL]
353683	0:06.625.705	83 ns			[1 SOF]

First Transaction

39.4 us lost between transfers

Only 6.6 us lost between transactions

Single Transfer

A significant improvement over losing ~40 us between each transaction!

Large Transfers

- What about Full Speed?
 - PIC32MX tops out around **8.6 Mbit/sec.**
 - **64 kB** transfer
 - Asynchronous API
 - Performance improvement with transfer size increase is not as dramatic:
 - **8.2 Mbit/sec** with 64-byte transfers
 - Asynchronous API



Large Transfers

- Limitations to large transfers
 - USB is a **message-based** protocol.
 - It's **convenient** to put one logical piece of data into its own transfer.
 - Packing multiple logical pieces of data into one large buffer **loses some of the benefit** of the USB protocol.
 - A **necessary trade-off** if performance is desired.
 - Queuing of messages can cause **increased latency** (marginal).



Other Considerations

- User space vs Kernel space
 - The above examples use the kernel's **Functionfs** interface on the **device** side.
 - Functionfs, using the `ffs-test.c` from mainline, takes **transfers** from a user space process synchronously.
 - Synchronous → delay between transfers
 - Mitigated by larger transfers
 - Functionfs can also use Linux's **Asynchronous I/O** capability
 - Better performance
 - `tools/usb/ffs-aio-example/`



Other Considerations

- User space vs Kernel Space (cont'd)
 - Custom gadget function driver
 - Can **queue** packets on the **device side** inside the kernel.
 - Queuing can happen even when the hardware is busy.



Custom Driver

- Driver details
 - Custom Driver has a queue of **32 transfers**
 - Device node at `/dev/user-gadget`
- Performance
 - BeagleBone Black:
 - **227** Mbit/sec, ~**7.6%** better than `ffs-test`
 - EG20T:
 - **328** Mbit/sec, ~**7.5%** better



Out Transfers

- One might expect **OUT** transfers to behave similarly to IN transfers.
- On musb, they **do not**
 - musb: Max throughput of **65.5 Mbit/sec**
 - Same for **sync and async**
 - 64 kB transfers
 - For data **received**, a DMA transfer is done for **every USB Transaction**.
 - Overhead is high
 - Large transfers don't help :(



Out Transfers

- On EG20T
 - Max throughput of **255 Mbit/sec**
 - 64 kB transfers
 - Still slower than IN transfers
 - Throughput scales with transfer size.



Results

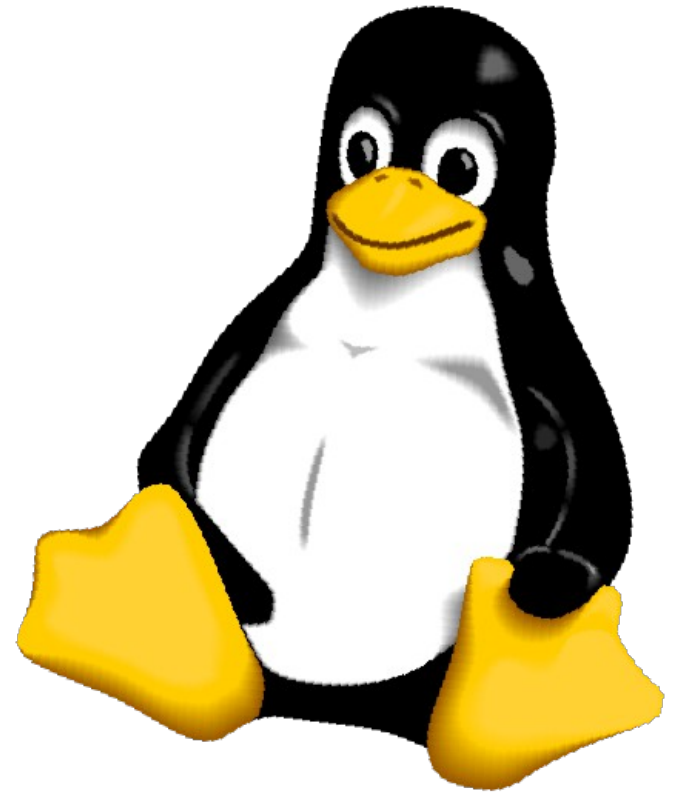

Test Methodology

- Test with the **synchronous** and **asynchronous** libusb API's
- Test **idle** and under **load**
 - **Device** load (musb):
 - `stress -c 1 -m 1`
 - **Device** load (EG20T):
 - `stress -c 2 -m 2`
 - *Host machine has one hyperthreaded core*
 - **Host** load:
 - `stress -c 4 -m 4`
 - *Host machine has 4 cores*

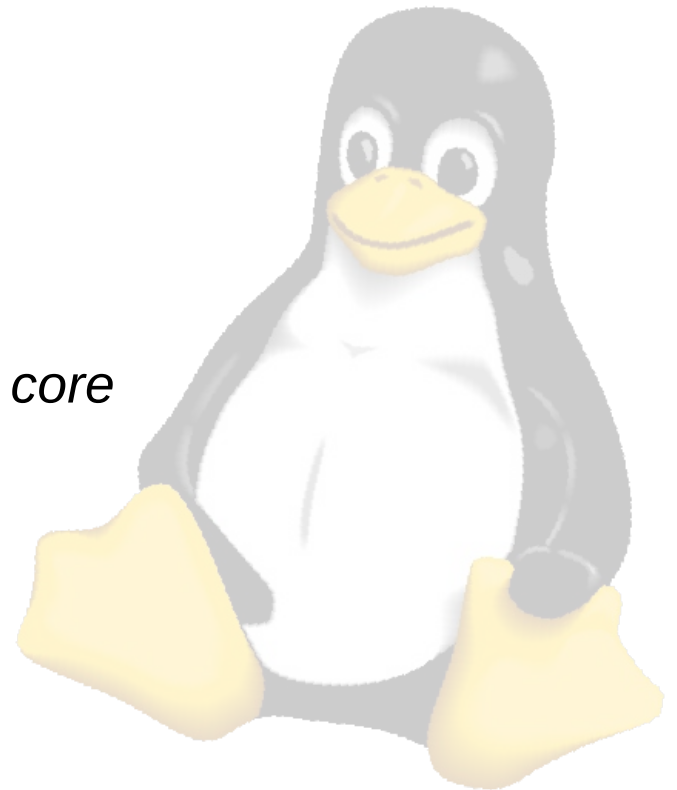

musb Results (IN Transfers)

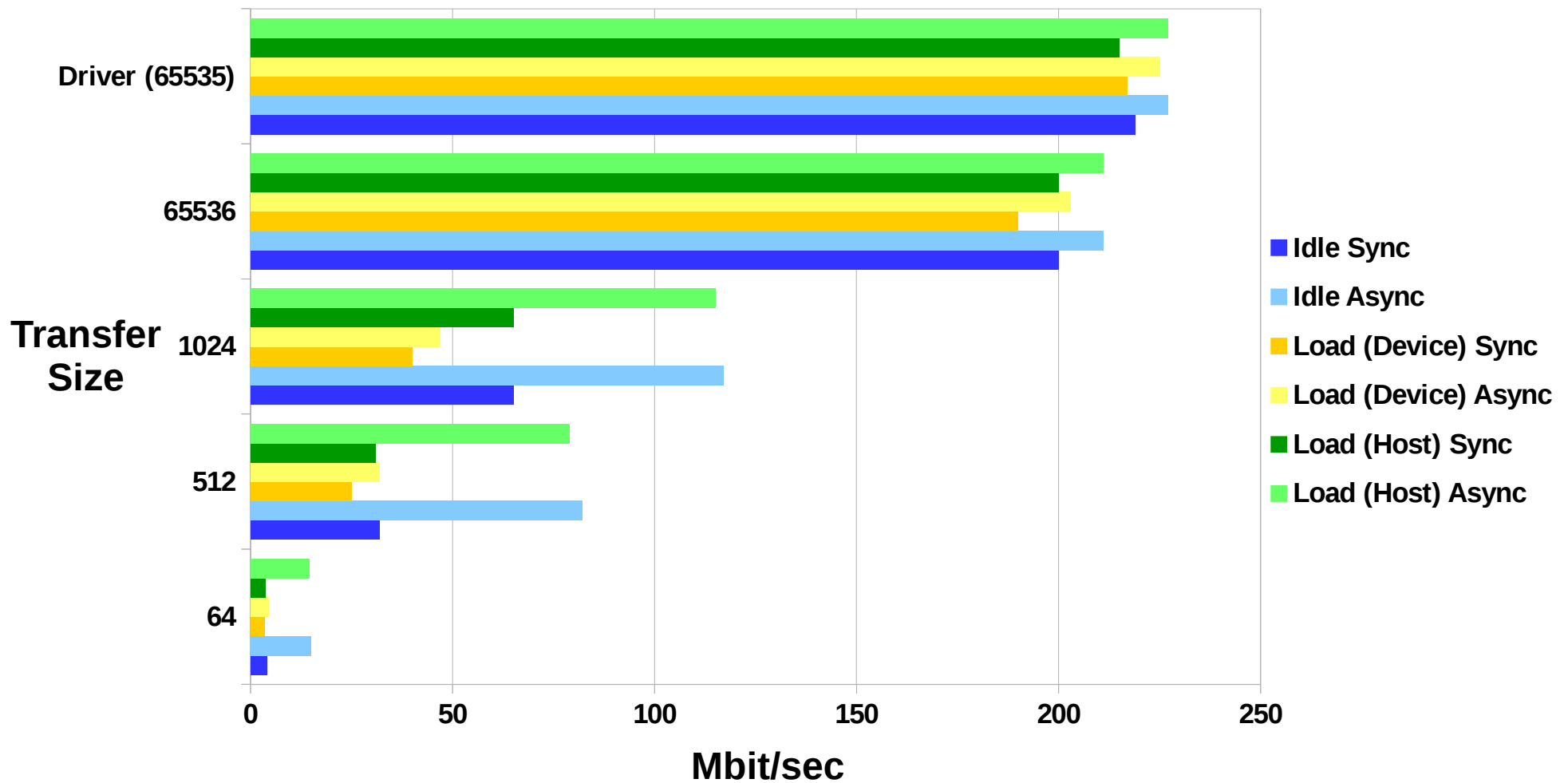

EG20T Results (IN Transfers)

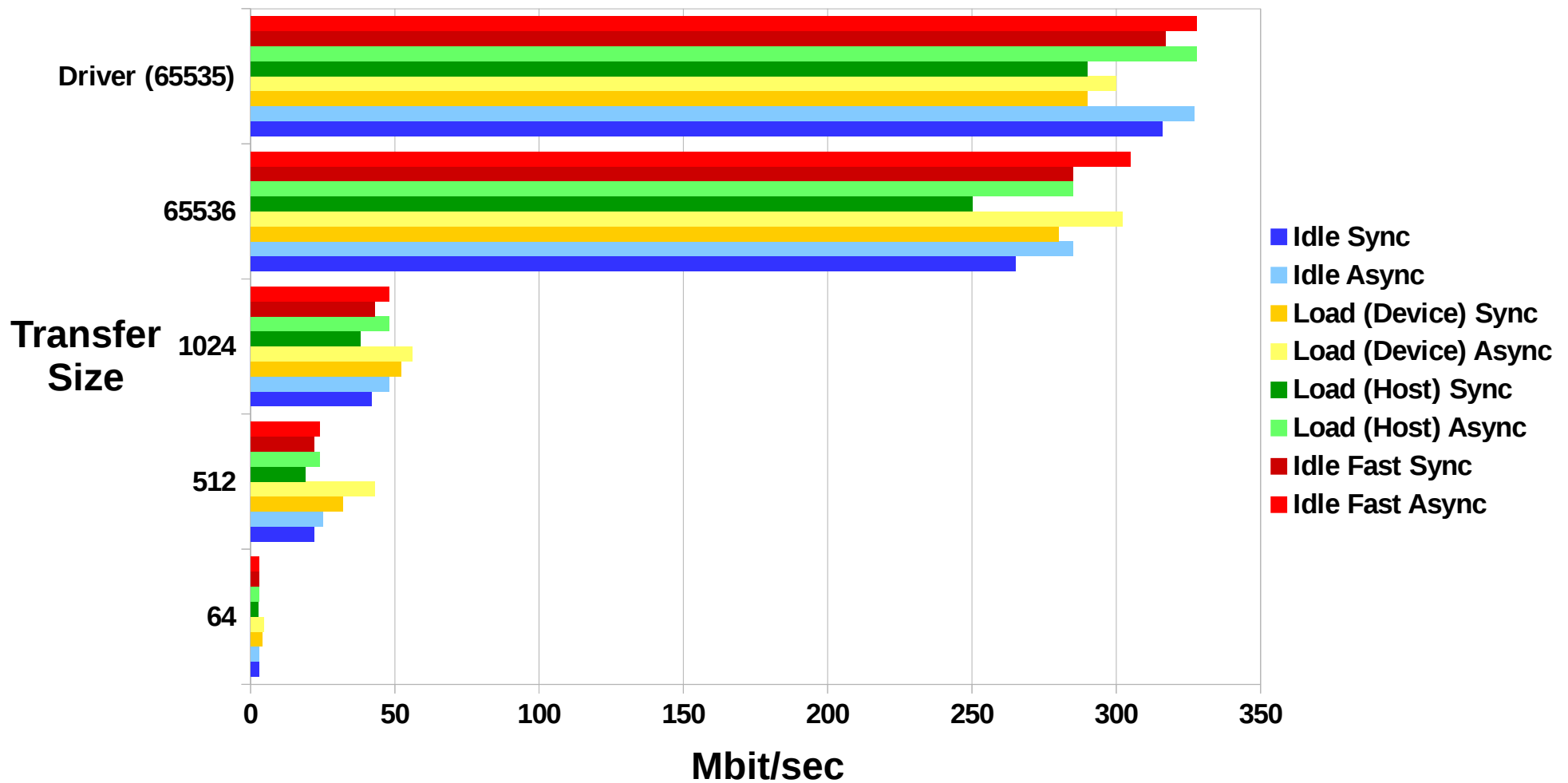

Results

- Warning:
 - Comparisons between controllers should be considered **cautiously**.
 - Plenty of **differences** between boards/platforms.
 - Different **CPU speeds** affect performance tremendously.
 - One hyperthreaded, one single core
 - We know what they say about benchmarks.
 - Use the data to compare effects **within** a controller type



Results

- musb/EG20T (Input) Analysis
 - **Larger transfer** size is **much** better
 - Sync/Async affects **smaller transfers** more than larger transfers.
 - Less time proportionally lost between transfers
 - Transfer size affects EG20T even more than musb
 - Host Load doesn't make much difference
 - Device Load makes **more** difference
 - Data is sourced from user space

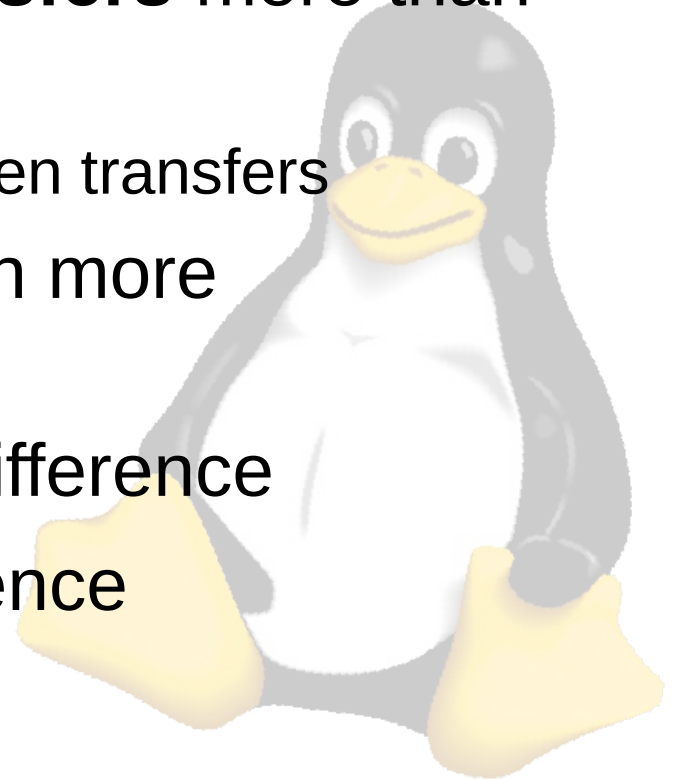

PIC32MX Results (IN Transfers)

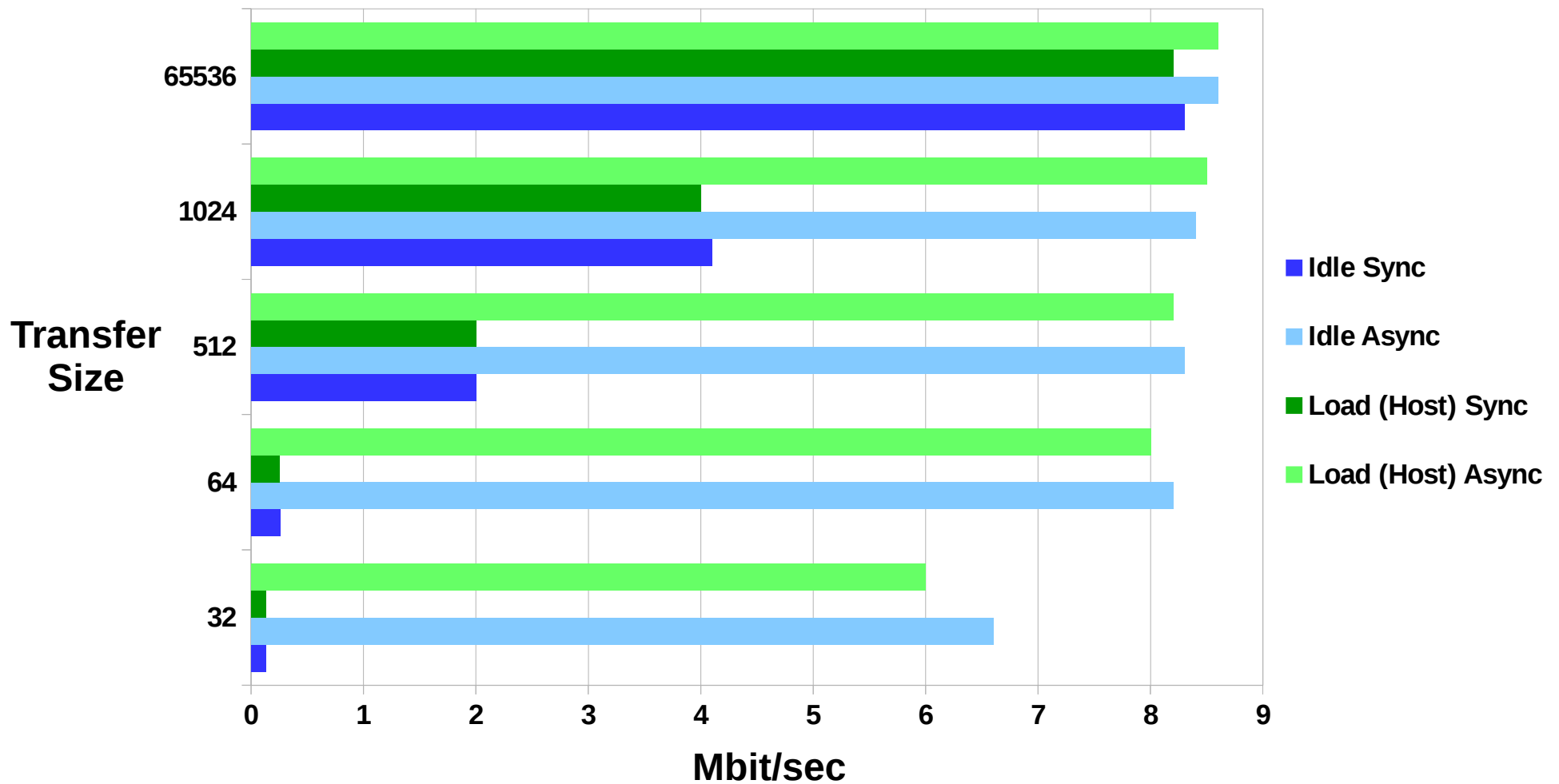

PIC32MX Results (IN TRF with hub)

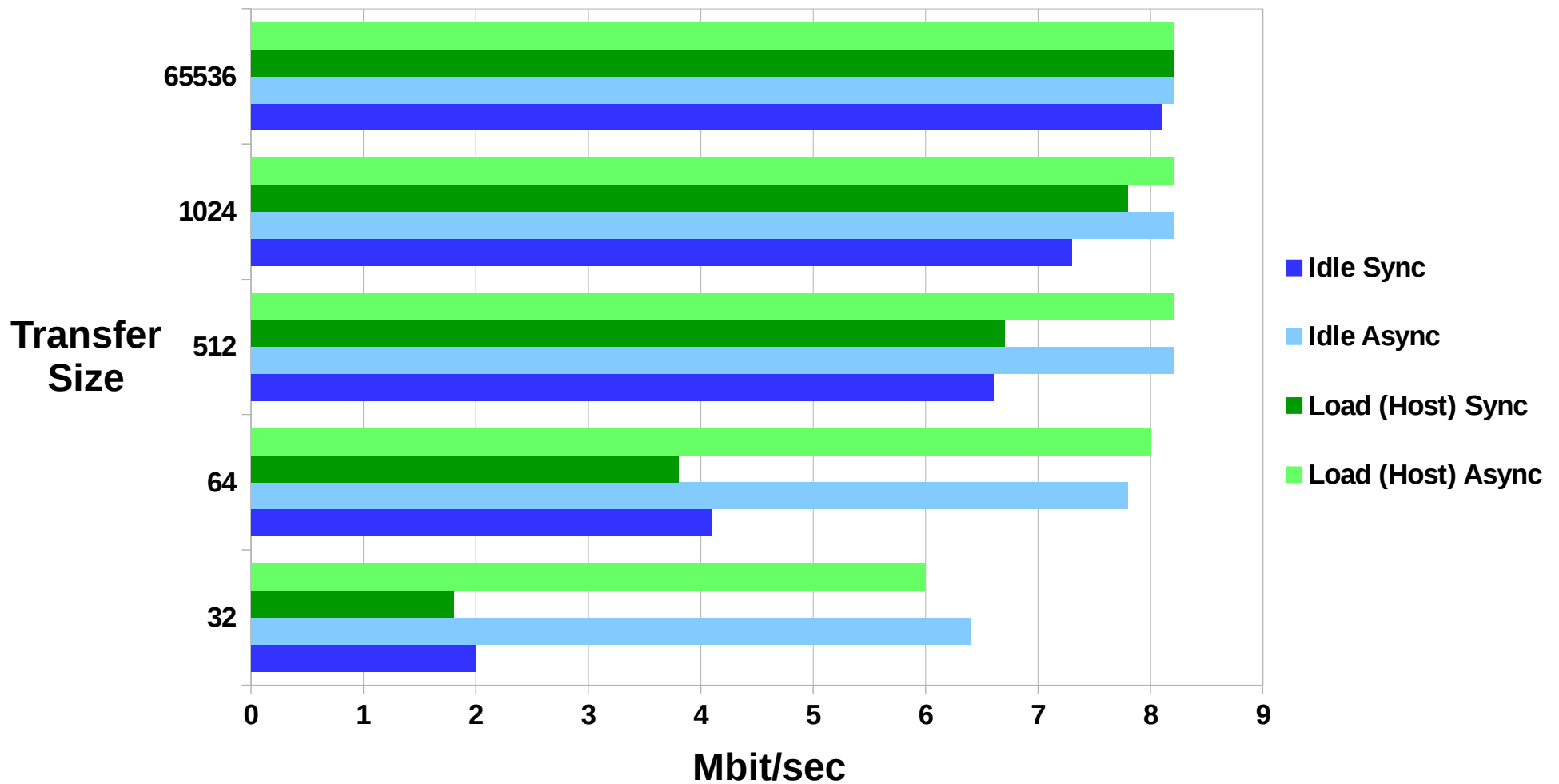

Results

- PIC32MX (Input) Analysis
 - **Larger transfer** sizes don't help as much for sync as they do for async.
 - Addition of a **hub** has a surprising affect
 - Analyzer shows **more frequent** IN tokens when connected through a hub.
 - Synchronous transfers are **faster**
 - Asynchronous transfers **slightly slower**
 - *The hub's **Transaction Translator (TT)** is affecting the performance*



musb Results (OUT Transfers)

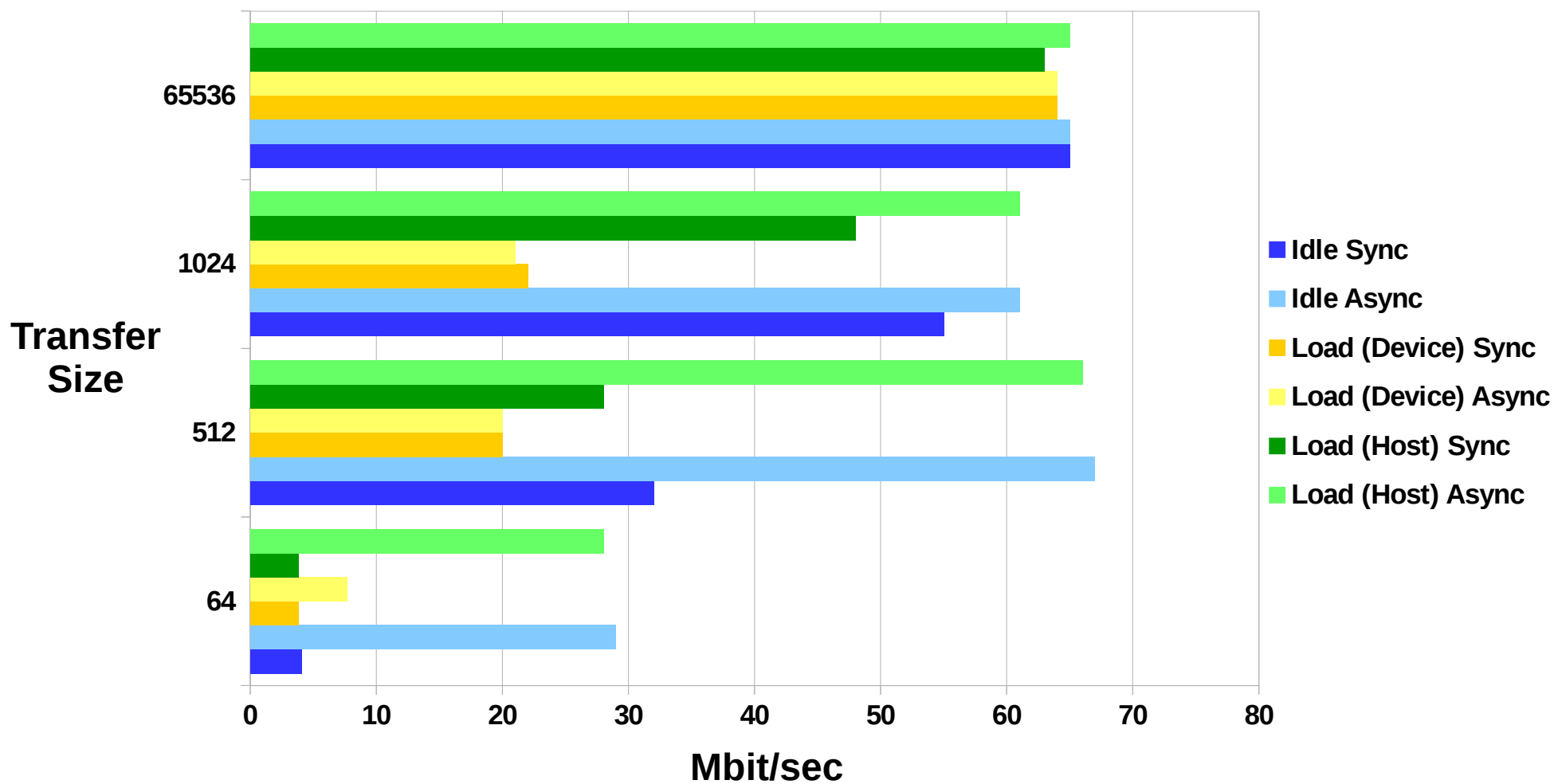

EG20T Results (OUT Transfers)

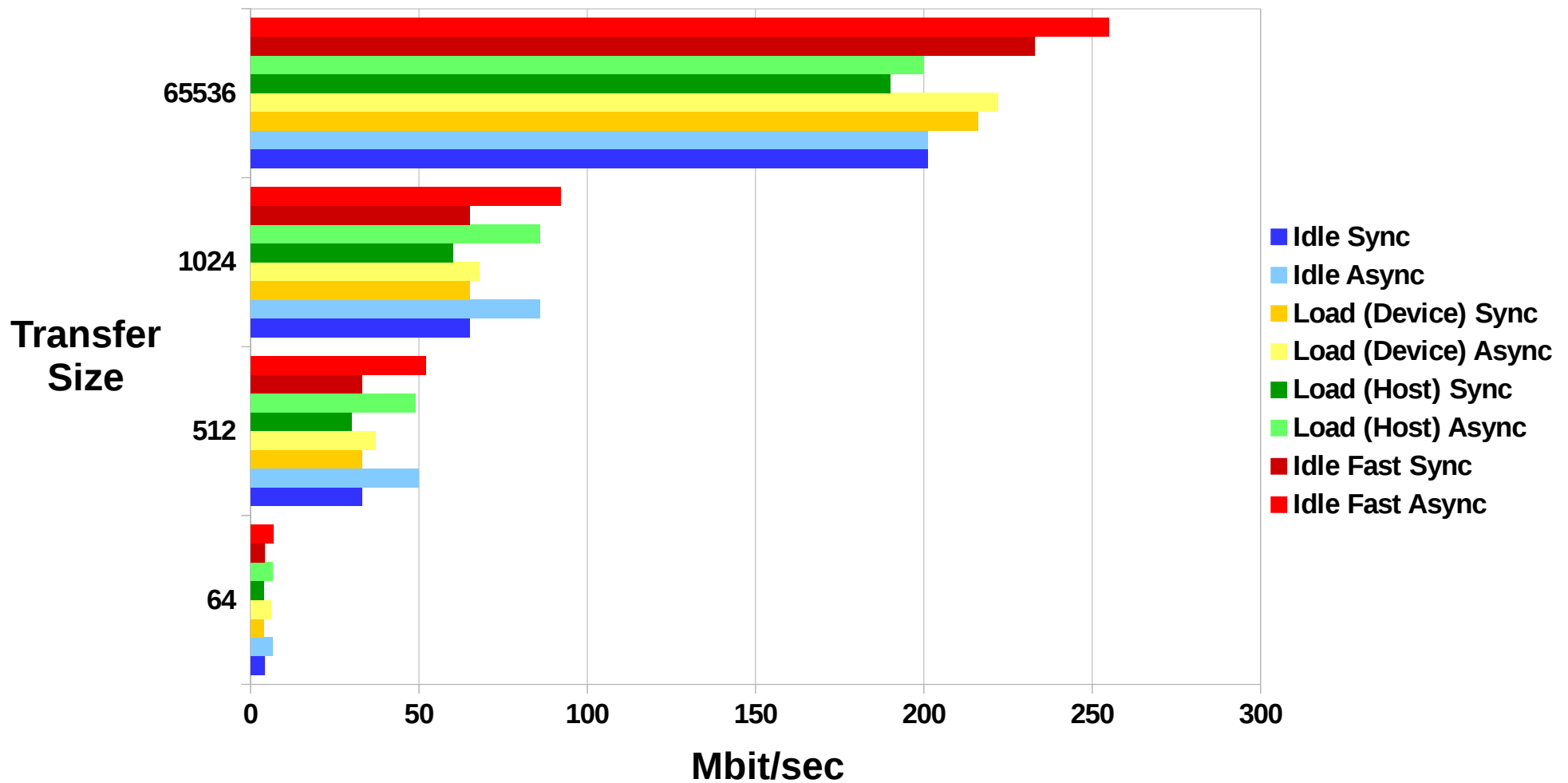

Results

- musb/EG20T (OUT) Analysis
 - musb does one DMA transfer **per USB transaction.**
 - musb OUT Performance **tops out** with 512-byte transfers
 - Endpoint size is 512.
 - EG20T OUT performance **scales similarly to IN** performance.
 - Hub numbers are similar but **slightly slower** (see spreadsheet)



PIC32MX Results (OUT Transfers)

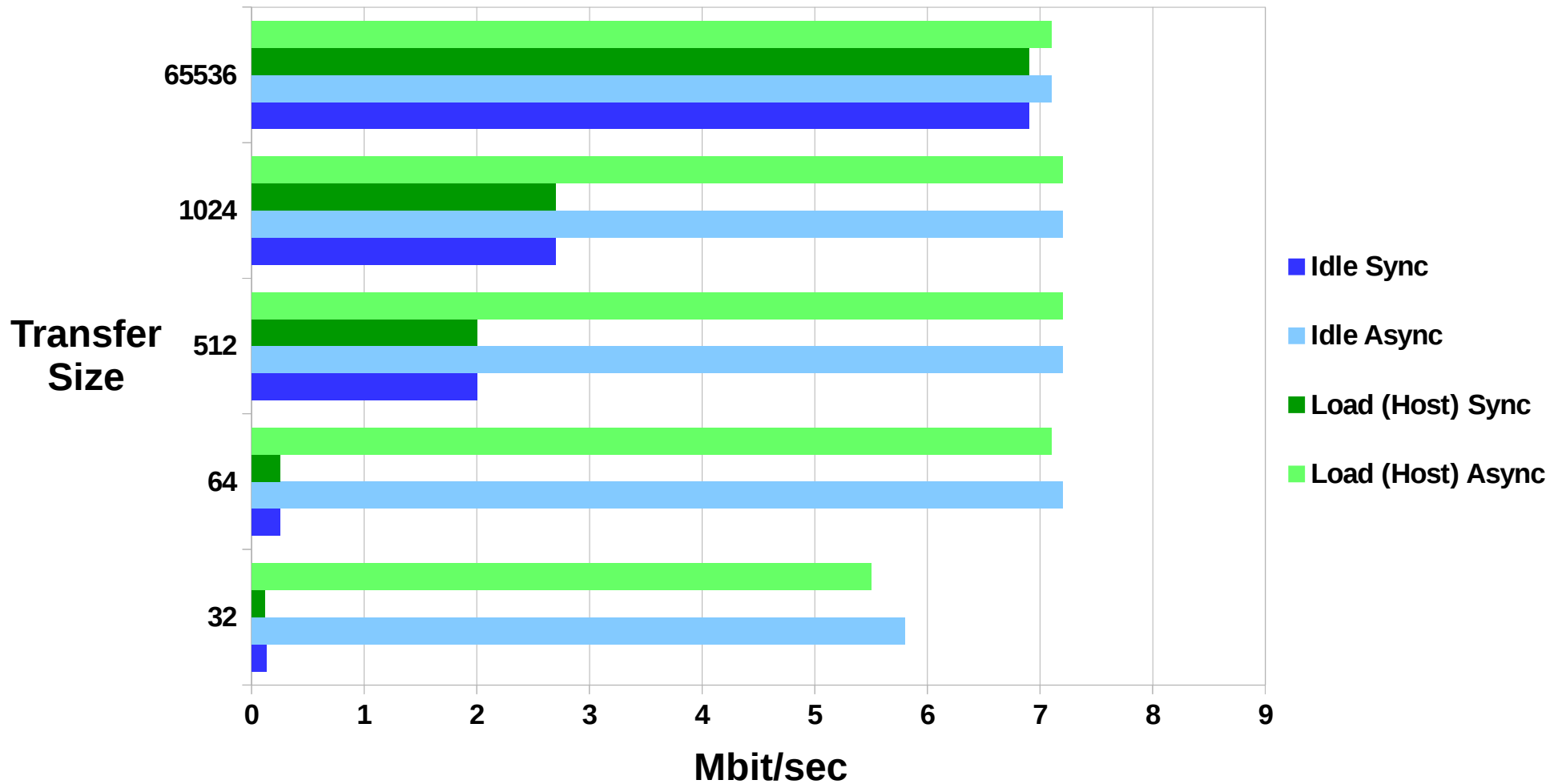

PIC32MX Results (OUT TRF with hub)

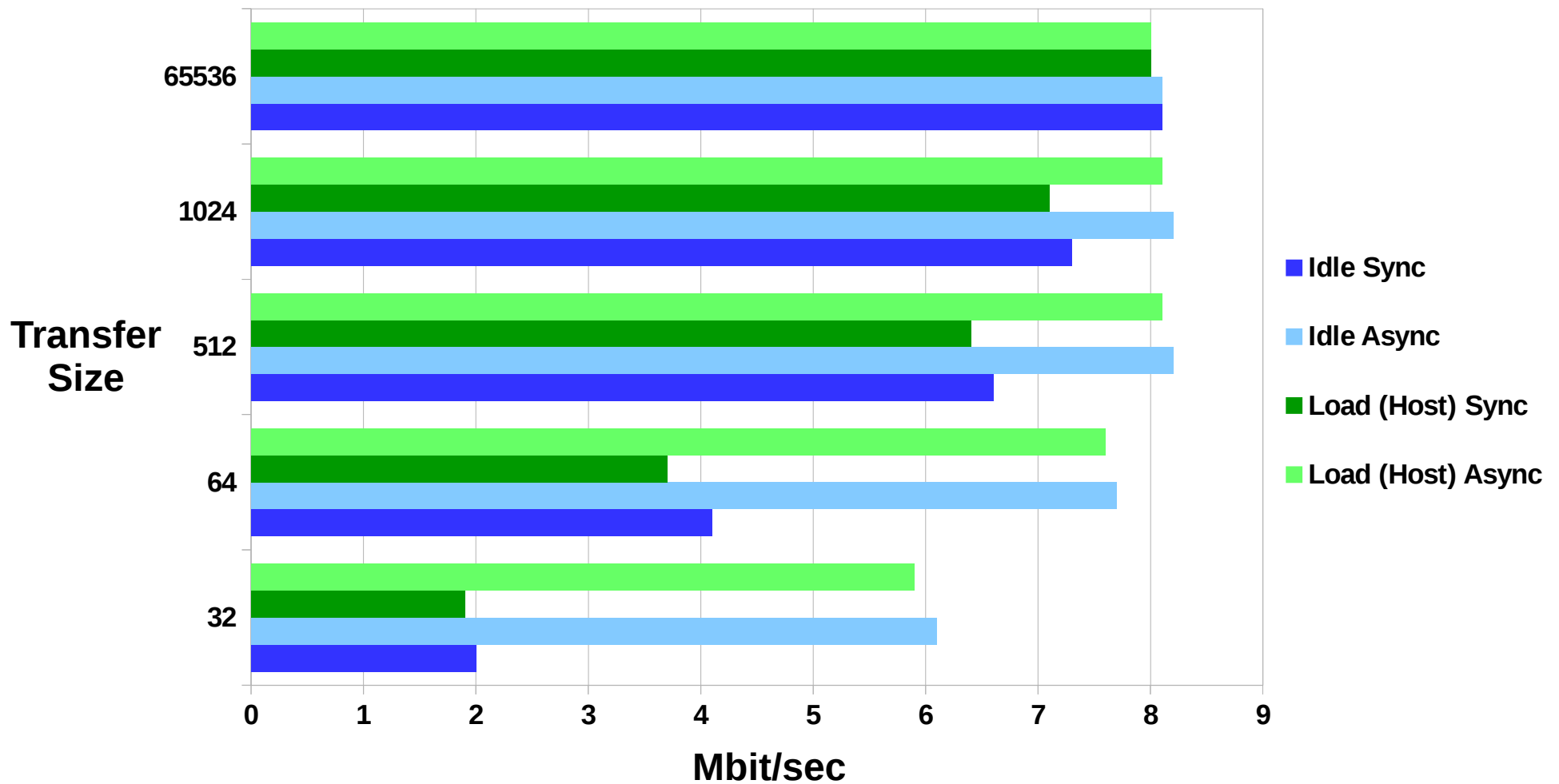

Results

- PIC32MX (Output) Analysis
 - OUT transfers are affected by the hub the same way IN transactions are
 - Speed is **comparable** to IN transfers



Further Optimizations

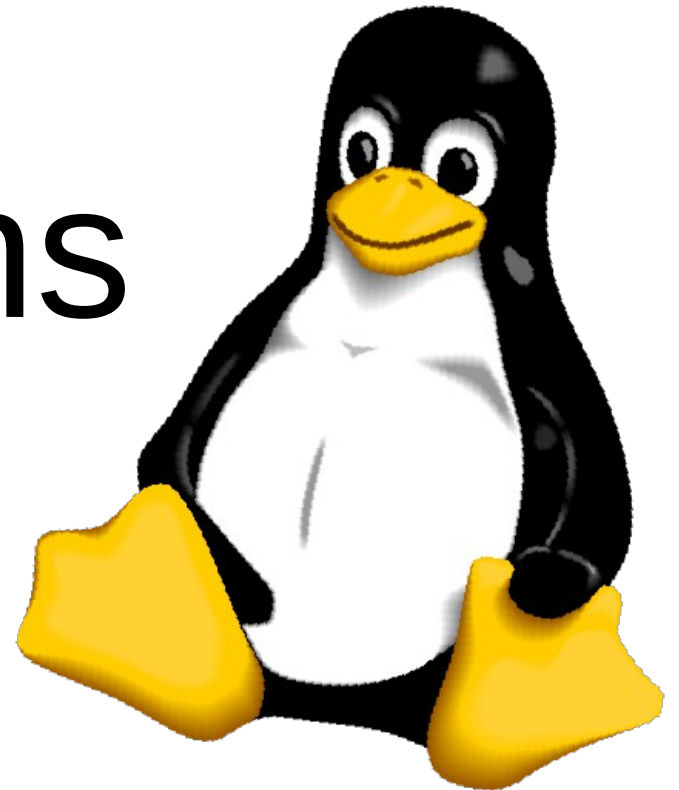

Isochronous Endpoints

- Features
 - **Un-acknowledged**, non-guaranteed
 - Bandwidth reserved
 - Up to 3×1024 bytes per 125us microframe
 - **3072** bytes/ μ frame: **196 Mbit/sec** per endpoint
- Issues
 - Requires AlternateSetting
 - Not supported by functionfs
 - Bandwidth must be available

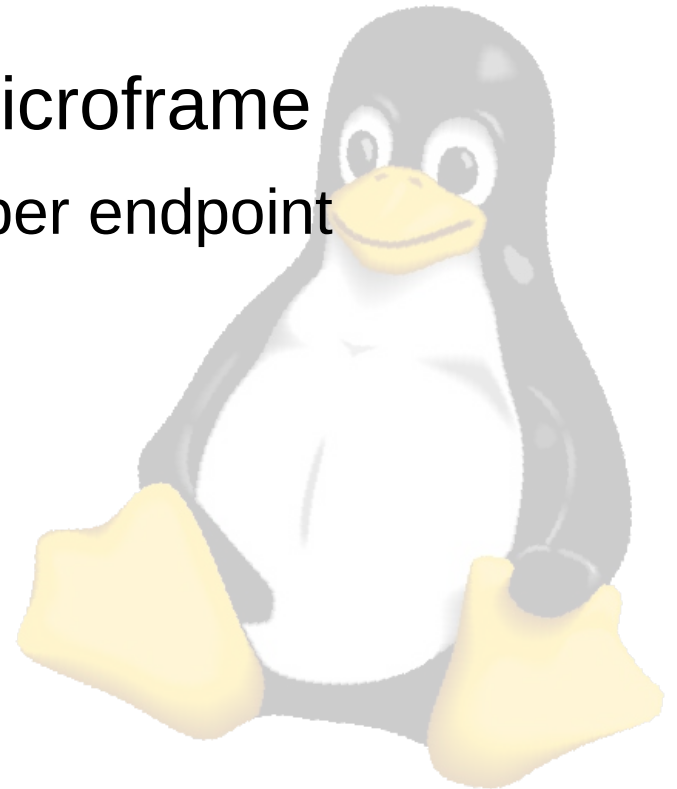

Multiple Endpoints

- Using **multiple bulk endpoints** can increase performance.
 - All endpoints and devices share **bus** time
 - If bottleneck is DMA, extra concurrency could increase performance.
 - More **complex** to manage.
 - Depends also on **host scheduling**.



High-Bandwidth Interrupt

- High-speed Interrupt endpoints at > 1024 bytes
 - Can go as high as **3072**
 - Reserved Bandwidth
 - Acknowledged
 - **AlternateSetting** required
 - Bus bandwidth **must be available**
 - Device will **fail to enumerate** or change AlternateSetting if bandwidth is not available.



Common Pitfalls

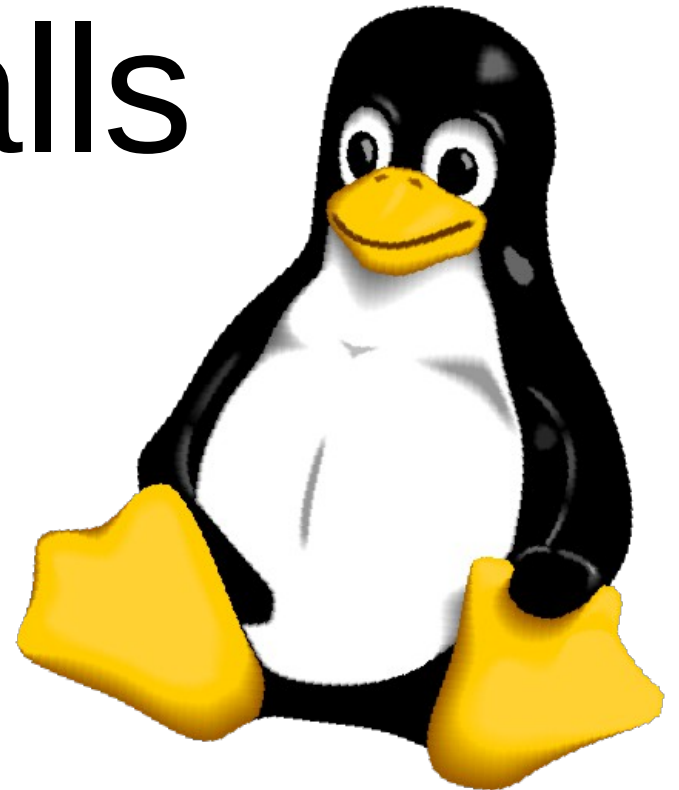

Common Pitfalls

- HID
 - Based on **Interrupt Transfers**.
 - Host will poll interrupt endpoints at up to once per **1ms frame** at **full speed**.
 - Interrupt transfers at full speed can be up to **64 bytes** in length.
 - Simple math is 64,000 bytes/sec
 - Good enough for many applications
 - Except....

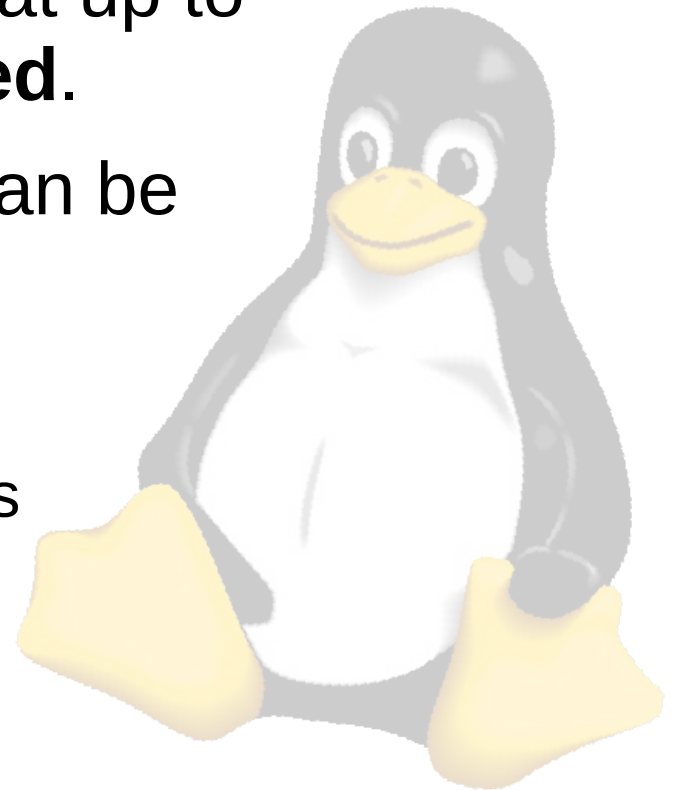

Common Pitfalls

- HID
 - ... Except you don't always get it! **Many hosts don't actually poll you that often!**
 - **2-4 frames** is much more realistic (sometimes worse!)
 - Some write **synchronous** protocols with HID
 - Those are even slower!
 - 2-4 frames for data, 2-4 frames for acknowledgement!
 - **8 kB/sec** in this case
 - Use **Bulk/Isoc** endpoints!
 - Use **libusb** on the host side



Common Pitfalls

- Serial Gadget
 - The `f_serial` gadget function creates `/dev/ttyGSn` nodes.
 - Data is written/read to/from these nodes from the **gadget/device** side.
 - Since the data goes through the **tty** framework, it is broken into **small transfers**.
 - Performance is **suboptimal**, but ease of use is high.

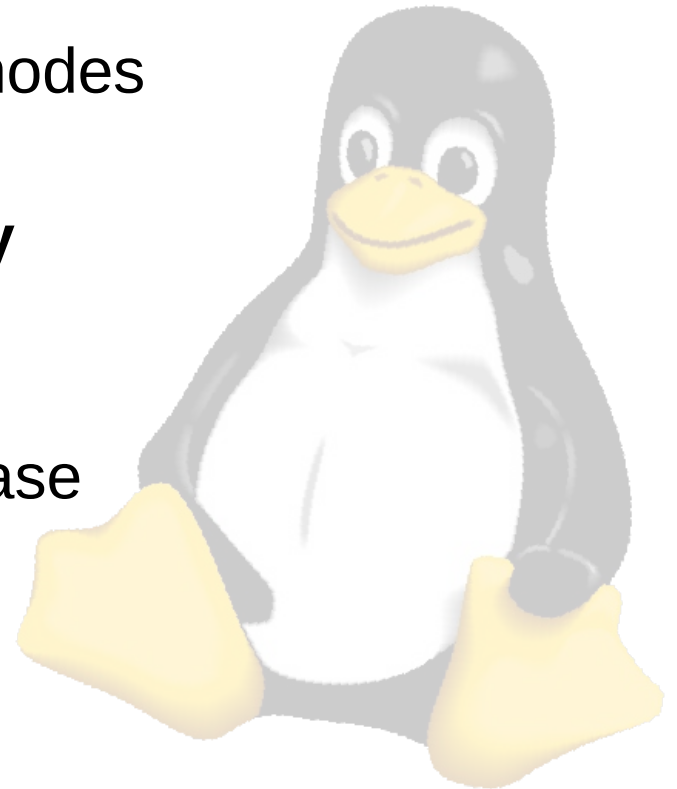

Tracepoint Analysis

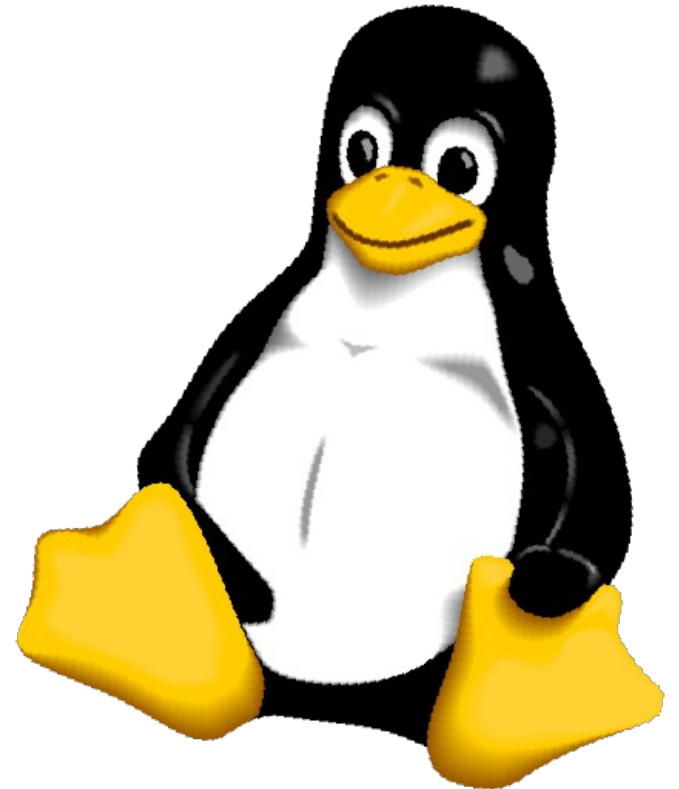

Tracepoints

- The kernel provides a **tracing** mechanism called `ftrace`.
 - Tracepoints are placed in source code
 - **Enabled/disabled** at runtime
 - Tracepoints can log **data**
 - **trace-cmd** utility to log data
 - **kernelshark** GUI to view/analyze it
 - Useful for finding latencies



Tracepoints

- Available Tracers
 - Additional tracers need to be enabled in `menuconfig`
 - Log every kernel function
 - Log max call stack size
 - Trace system calls
 - Scheduling latency
 - Others...



KernelShark

- **GUI** for trace analysis
 - Graphically show tracepoints
 - Per-CPU
 - Per-process
 - Show tracepoint data
 - Complex **filtering**
 - By process, CPU, event type or name
 - Excellent documentation
 - <http://people.redhat.com/srostedt/kernelshark/HTML/>



Tracepoints

- musb driver was **modified** to add tracepoints
 - Declare tracepoints:
 - musb-trace.h
 - Call tracepoint functions (with data):
 - musb_gadget.c
 - musbhsdma.c



KernelShark

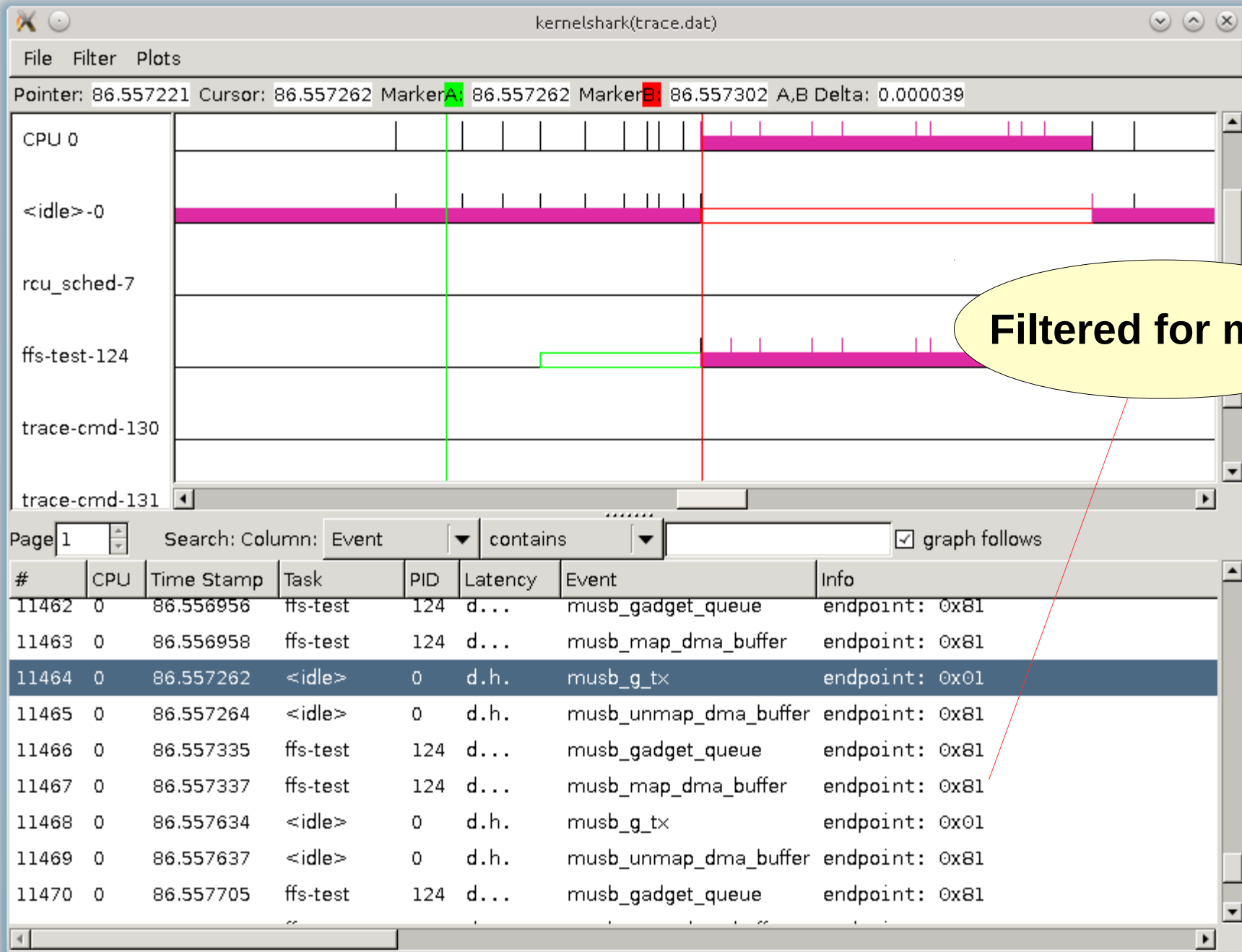

Filtered for musb

Tracepoints

- Results
 - Results show the **latency** involved in the **context switch**.
 - Along with DMA overhead, another reason to use large transfers.



Lessons Learned

- Gadget interface is Fragile
- Functionfs doesn't support AltSettings
 - No Isochronous endpoints
 - No high-bandwidth Interrupt endpoints
- Performance is host-dependent
- Hubs
 - Can have strange effects
 - Some good, some bad.



Signal11

S O F T W A R E

Alan Ott

alan@signal11.us

www.signal11.us

+1 407-222-6975 (GMT -5)

